

Soundweb™ London
**BLU-800/BLU-320/BLU-160/
BLU-120**
Installation Guide
18-0553-A

IMPORTANT SAFETY INSTRUCTIONS



CAUTION

RISK OF ELECTRIC SHOCK
DO NOT OPEN



ATTENTION: RISQUE DE CHOQUE ELECTRIQUE - NE PAS OUVRIR

WARNING: TO REDUCE THE RISK OF FIRE OR ELECTRIC SHOCK DO NOT EXPOSE THIS EQUIPMENT TO RAIN OR MOISTURE

The symbols shown above are internationally accepted symbols that warn of potential hazards with electrical products. The lightning flash with arrowpoint in an equilateral triangle means that there are dangerous voltages present within the unit. The exclamation point in an equilateral triangle indicates that it is necessary for the user to refer to the owner's manual.

These symbols warn that there are no user serviceable parts inside the unit. Do not open the unit. Do not attempt to service the unit yourself. Refer all servicing to qualified personnel. Opening the chassis for any reason will void the manufacturer's warranty. Do not get the unit wet. If liquid is spilled on the unit, shut it off immediately and take it to a dealer for service. Disconnect the unit during storms to prevent damage.

SAFETY INSTRUCTIONS

NOTICE FOR CUSTOMERS IF YOUR UNIT IS EQUIPPED WITH A POWER CORD.

WARNING: THIS APPLIANCE SHALL BE CONNECTED TO A MAINS SOCKET OUTLET WITH A PROTECTIVE EARTHING CONNECTION.

The cores in the mains lead are coloured in accordance with the following code:

GREEN and YELLOW - Earth BLUE - Neutral BROWN - Live

As colours of the cores in the mains lead of this appliance may not correspond with the coloured markings identifying the terminals in your plug, proceed as follows:

- The core which is coloured green and yellow must be connected to the terminal in the plug marked with the letter E, or with the earth symbol, or coloured green, or green and yellow.
- The core which is coloured blue must be connected to the terminal marked N or coloured black.
- The core which is coloured brown must be connected to the terminal marked L or coloured red.

This equipment may require the use of a different line cord, attachment plug, or both, depending on the available power source at installation. If the attachment plug needs to be changed, refer servicing to qualified service personnel who should refer to the table below. The green/yellow wire shall be connected directly to the units chassis.

CONDUCTOR		WIRE COLOR	
		Normal	Alt
L	LIVE	BROWN	BLACK
N	NEUTRAL	BLUE	WHITE
E	EARTH GND	GREEN/YEL	GREEN

WARNING: If the ground is defeated, certain fault conditions in the unit or in the system to which it is connected can result in full line voltage between chassis and earth ground. Severe injury or death can then result if the chassis and earth ground are touched simultaneously.

WARNING FOR YOUR PROTECTION PLEASE READ THE FOLLOWING:

KEEP THESE INSTRUCTIONS

HEED ALL WARNINGS

FOLLOW ALL INSTRUCTIONS

THE APPARATUS SHALL NOT BE EXPOSED TO DRIPPING OR SPLASHING LIQUID AND NO OBJECT FILLED WITH LIQUID, SUCH AS VASES, SHALL BE PLACED ON THE APPARATUS

CLEAN ONLY WITH A DRY CLOTH.

DO NOT BLOCK ANY OF THE VENTILATION OPENINGS. INSTALL IN ACCORDANCE WITH THE MANUFACTURER'S INSTRUCTIONS.

DO NOT INSTALL NEAR ANY HEAT SOURCES SUCH AS RADIATORS, HEAT REGISTERS, STOVES, OR OTHER APPARATUS (INCLUDING AMPLIFIERS) THAT PRODUCE HEAT.

ONLY USE ATTACHMENTS/ACCESSORIES SPECIFIED BY THE MANUFACTURER.

UNPLUG THIS APPARATUS DURING LIGHTNING STORMS OR WHEN UNUSED FOR LONG PERIODS OF TIME.

Do not defeat the safety purpose of the polarized or grounding-type plug. A polarized plug has two blades with one wider than the other. A grounding type plug has two blades and a third grounding prong. The wide blade or third prong are provided for your safety. If the provided plug does not fit your outlet, consult an electrician for replacement of the obsolete outlet.

Protect the power cord from being walked on or pinched particularly at plugs, convenience receptacles, and the point where they exit from the apparatus.

Use only with the cart stand, tripod bracket, or table specified by the manufacture, or sold with the apparatus. When a cart is used, use caution when moving the cart/apparatus combination to avoid injury from tip-over.



Refer all servicing to qualified service personnel. Servicing is required when the apparatus has been damaged in any way, such as power-supply cord or plug is damaged, liquid has been spilled or objects have fallen into the apparatus, the apparatus has been exposed to rain or moisture, does not operate normally, or has been dropped.

POWER ON/OFF SWITCH: For products provided with a power switch, the power switch DOES NOT break the connection from the mains.

MAINS DISCONNECT: The plug shall remain readily operable. For rack-mount or installation where plug is not accessible, an all-pole mains switch with a contact separation of at least 3 mm in each pole shall be incorporated into the electrical installation of the rack or building.

FOR UNITS EQUIPPED WITH EXTERNALLY ACCESSIBLE FUSE RECEPTACLE: Replace fuse with same type and rating only.

MULTIPLE-INPUT VOLTAGE: This equipment may require the use of a different line cord, attachment plug, or both, depending on the available power source at installation. Connect this equipment only to the power source indicated on the equipment rear panel. To reduce the risk of fire or electric shock, refer servicing to qualified service personnel or equivalent.

IMPORTANT SAFETY INSTRUCTIONS

DECLARATION OF CONFORMITY

Manufacturer's Name: BSS Audio
 Manufacturer's Address: 8760 S. Sandy Parkway
 Sandy, Utah 84070, USA

declares that the product:

Product name: BLU 120, BLU 160, BLU 320, BLU 800
 Note: Product name may be suffixed by the letters-EU.

Product option: Various combinations of Input / Output Cards

conforms to the following Product Specifications:

Safety: EN 60065 (7th ed. 2001)

EMC: EN 55103 (2001+A1)
 EN 55103 (1998)

Supplementary Information:

The product herewith complies with the requirements of the Low Voltage Directive 73/23/EEC and the EMC Directive 89/336/EEC as amended by Directive 93/68/EEC.

Director of Engineering – BSS Audio
 8760 S. Sandy Parkway
 Sandy, Utah 84070, USA

Date: February 1, 2008

European Contact: Your local BSS Audio Sales and Service Office or

Harman Music Group
 8760 South Sandy Parkway
 Sandy, Utah 84070, USA
 Ph: (801) 566-8800
 Fax: (801) 566-7005

U.K. MAINS PLUG WARNING

A molded mains plug that has been cut off from the cord is unsafe. Discard the mains plug at a suitable disposal facility. **NEVER UNDER ANY CIRCUMSTANCES SHOULD YOU INSERT A DAMAGED OR CUT MAINS PLUG INTO A 13 AMP POWER SOCKET.** Do not use the mains plug without the fuse cover in place. Replacement fuse covers can be obtained from your local retailer. Replacement fuses are 13 amps and **MUST** be ASTA approved to BS1362.

ELECTROMAGNETIC COMPATIBILITY

This unit conforms to the Product Specifications noted on the **Declaration of Conformity**. Operation is subject

to the following two conditions:

- this device may not cause harmful interference, and
- this device must accept any interference received, including interference that may cause undesired operation.

Operation of this unit within significant electromagnetic fields should be avoided.

- use only shielded interconnecting cables.



If you want to dispose this product, do not mix it with general household waste. There is a separate collection system for used electronic products in accordance with legislation that requires proper treatment, recovery and recycling.

Private household in the 25 member states of the EU, in Switzerland and Norway may return their used electronic products free of charge to designated collection facilities or to a retailer (if you purchase a similar new one).

For Countries not mentioned above, please contact your local authorities for a correct method of disposal.

By doing so you will ensure that your disposed product undergoes the necessary treatment, recovery and recycling and thus prevent potential negative effects on the environment and human health.



Regulatory information

An example of this equipment has been tested and found to comply with the following European and international Standards for Electromagnetic Compatibility and Electrical Safety:

Radiated Emissions (EU): EN55013 (2001+A1)
Immunity (EU): EN55020 (1998)
Electrical Safety (EU): IEC60065-01 + AMD1
Electrical safety (USA): UL60065-06



Important user information

Do not remove covers. No user serviceable parts inside, refer servicing to qualified service personnel. For continued compliance with international EMC regulations, it is important that all cables be screened, and connected as follows: Audio cable screens to their BLU-800 connector ground. Control cable screens to the ground screws adjacent to the connector. Network cables should be of type CAT.5, fitted with a clip-on ferrite sleeve (STEWART TYPE 28A2029-0A0) near the network socket end. This equipment must be earthed. It should not be necessary to remove any protective earth or signal cable shield connections to prevent ground loops. Any such disconnections are outside the recommended practice of BSS Audio, and will render the EMC or safety certificate void.

Mechanical installation

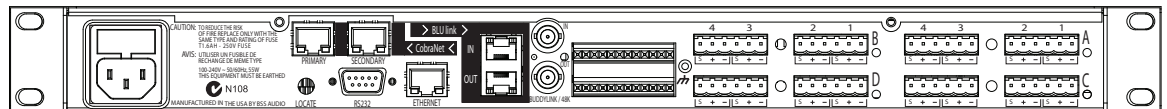

If the unit is likely to undergo extreme vibration through extensive road trucking and touring, the unit must be supported at the rear and/or sides to lessen the stress on the front mounting flange. Rear rack supports are provided to reduce stress on front mounting flange. Damage caused by insufficient support is not covered by the warranty. To prevent cosmetic damage to the front panel finish, use protective plastic cups under the rack mounting bolts.



Front panel Input card monitoring

Each channel has 3 LED indicators showing:



Clip

Illuminated - Indicates clipping in the analogue domain for each channel of the fitted Input or Output card. The LED will illuminate at +18.5dB.

Signal

Illuminated - The Signal LED will illuminate for each channel of a fitted Input or Output card when the signal reaches or exceeds the signal threshold of -20dB.

Phantom

Illuminated - Illuminates to indicate +48V phantom power has been activated for the relevant channel of a fitted input card.

Conductor

The master clock device of a CobraNet™ system is referred to as the Conductor - the CM-1 modules in the system auto-negotiate which device will transmit the Conductor beat packet. The LED illuminates to indicate which device is acting as the Conductor.

Network Link

The Network Link indicates the presence of Cat 5 Ethernet cables. If no cables are connected, the LED is unlit; the LED flashes if either a control or CobraNet™ cable is fitted and remains illuminated if both cables are connected.

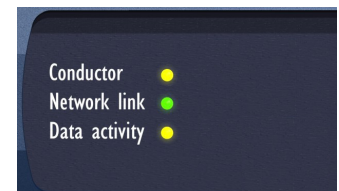

Data Activity

The Data Activity LED will flash to indicate that the device is communicating with another control device, either on the network or via the serial or control ports.

LCD Display

Top line Indicates device name and run state.

Bottom line indicates Time, IP Address, Subnet Mask, Model number with firmware version.

LOCATE

Pressing the Locate switch on the front of the unit will illuminate the Locate switch on the rear and identify the device within London Architect. Similarly the switch will illuminate if the device is selected from within London Architect or from the Locate switch on the rear.



Contrast (Hold)

Pressing and holding the Locate switch will cycle the LCD through its contrast range.

Audio cable wiring

All audio and control connections to the BLU-800/BLU-320/BLU-160/BLU-120 are via Klippon pluggable terminal block connectors (also known as BL, Phoenix or Combicon). 6-way female Klippon connectors are supplied for making these connections.

Audio Input and Output wiring convention

Soundweb products provide cable shielding 'back from the destination' to eliminate ground loop problems. This means that the shield (S) connection on an input is grounded, whereas the shield connection on an output is floating (although connected via an internal network to ground for EMC compliance).

Balanced wiring - The convention for balanced wiring (2-core plus shield) is:

Balanced connection BLU-800 connection

Pin 3: Cold '-'
Pin 2: Hot '+'
Pin 1: Shield



Unbalanced wiring - The convention for unbalanced wiring to the inputs (1-core plus shield) is:

Unbalanced connection BLU-800 connection

Pin 1: Shield
Pin 2: Hot '+'
Pin 3: Link to Pin 1
(Optional for BLU-800 inputs)

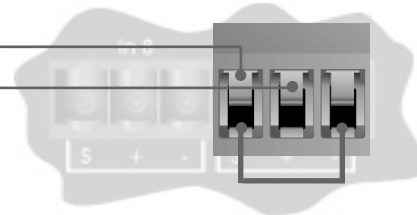

Rear panel

BLU-800 shown. BLU-320 layout is identical.

BLU-160 and BLU-120 have no CobraNet™ or Buddy Link connections but is otherwise identical to the BLU-800 and BLU-320.

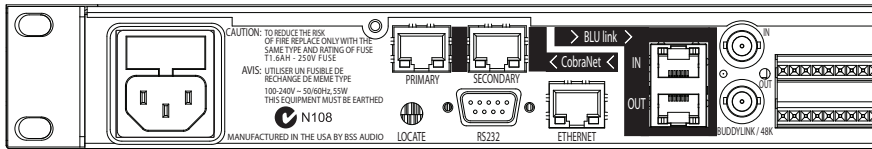

AC Mains

AC Mains input to the universal switched-mode power supply, operates over a wide range of AC input voltages from 100V to 240V, 50/60Hz.

CobraNet Connectors - Primary/Secondary

The CobraNet™ compatible devices within the Soundweb™ London system are fitted with a Peak Audio Cobranet™ CM-1 module. The module itself offers a Primary and a Secondary Cobranet™ port. Under normal operation the Primary port only receives audio data from and transmits audio data to the network. Should the Primary port or connection fail, the CM-1 module automatically switches to receive from and transmit with the Secondary port.

Locate

Pressing the Locate switch on the rear of the unit will illuminate the Locate switch on the front and identify the device within London Architect. Similarly the switch will illuminate if the device is selected from within London Architect or from the Locate switch on the front panel.

RS232

Serial port for connection of external control equipment.

Ethernet

The main connection for the proprietary system control network, and for third party Ethernet control.

BLU link

The London BLU link is a point-to-point digital audio bus with 256 audio channels at 48K sample rate or 128 audio channels at 96K sample rate. The physical connection is made with cat5e cable from the OUT port of one device to the IN port of another device. The devices are connected in a daisy chain fashion continuing with the OUT port of one device connected to the IN port of the next device. Redundancy can be provided by completing the loop and connecting the OUT port from the last device to the IN port of the first device in the chain. All devices connected in the London BLU link chain must be configured for the same audio sample rate.

Buddy Link/48k

The CobraNet™ Buddy Link In/Out BNC connectors allow two similarly configured Soundweb London devices to be linked together and operate as a redundant pair with fail-over capability. A 48kHz system clock is generated at the Buddy Link Out port.

I/O Card Positions A, B, C and D

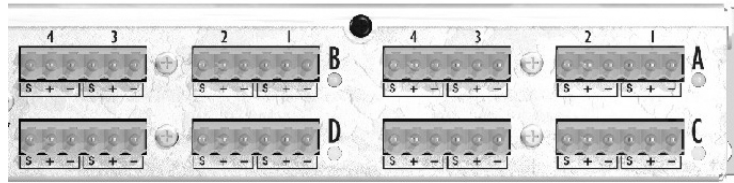

These connectors provide the balanced connections for the I/O card fitted in the four card slots in a Soundweb London device. A green LED next to the slot assignment letter A, B, C or D indicates that an Input card is fitted and an amber LED when an output card is fitted. The analogue connections are balanced, on Phoenix/Combicon connectors. Digital input cards are indicated with a blue LED and digital outputs cards with a red LED.

CONTROL INPUTS

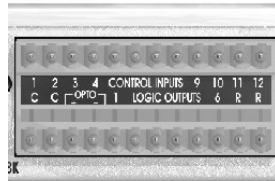

Used to connect switches or potentiometers, e.g. BLU-3 selector wallplate (Part no. Z-BLU-3). Looking at the control port connector (on the back of the unit), there are two common (ground) connections C to the left of the eight CONTROL INPUTS and, two software assignable reference voltage outputs R to the right.

The control ports now have two modes of operation. In Soundweb Designer's Control Ports window these are labelled '2-wire' and '3-wire'.

2-wire mode

In this mode the eight CONTROL INPUTS are internally 'pulled up' to +5V DC via a 4.7kOhm resistor. Therefore, no external voltage source is needed to create contact closure to ground for switches such as mute buttons or, resistance to ground (for other multi-state or continuous controls such as Parameter Presets or faders).

See the Soundweb Designer help for a table of resistor values for use with Parameter Presets or source selectors.

Two 'common' ground connections are provided using the two C connectors to the left of the CONTROL INPUTS.

A 47kOhm-log potentiometer (Part no. DM10018) connected between a control input and common will allow parameters to be controlled linearly.

3-wire mode

This mode allows the use of linear pots or faders for continuous controls. A pot would be wired as a potential divider with the top of the track connected to the reference output R, the wiper to a control input and the bottom of the track to a common C. For good performance pots with track resistance between 10 and 100KOhms are recommended.

LOGIC OUTPUTS

Used to connect 'tally' indicator LED's or relays.

There are six standard LOGIC OUTPUTS which produce 0V or +5V DC via an internal 440 Ohm resistor and two internally connected common (ground) connections C.

An LED connected between one output (Anode, A) and common (Cathode, K) will illuminate when the logic output is activated, without requiring any external current limiting resistor.

A high sensitivity relay (such as a reed relay) may be driven by connecting four outputs in parallel. This arrangement will develop 4V across a 500-Ohm coil, providing that all four outputs are made logic 1 simultaneously.

OPTO Output

In addition to the eight standard logic outputs, there is an isolated output, which fails safe (open circuit) if the unit becomes faulty.

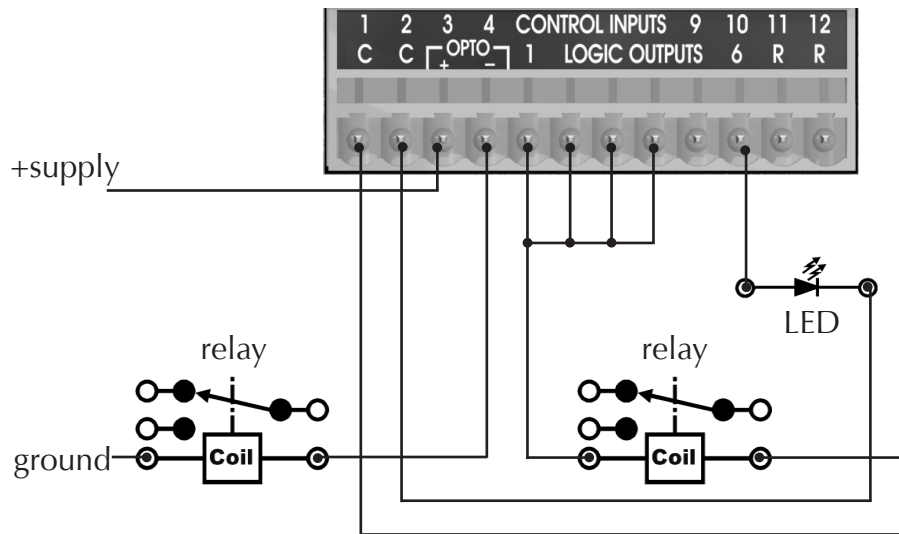
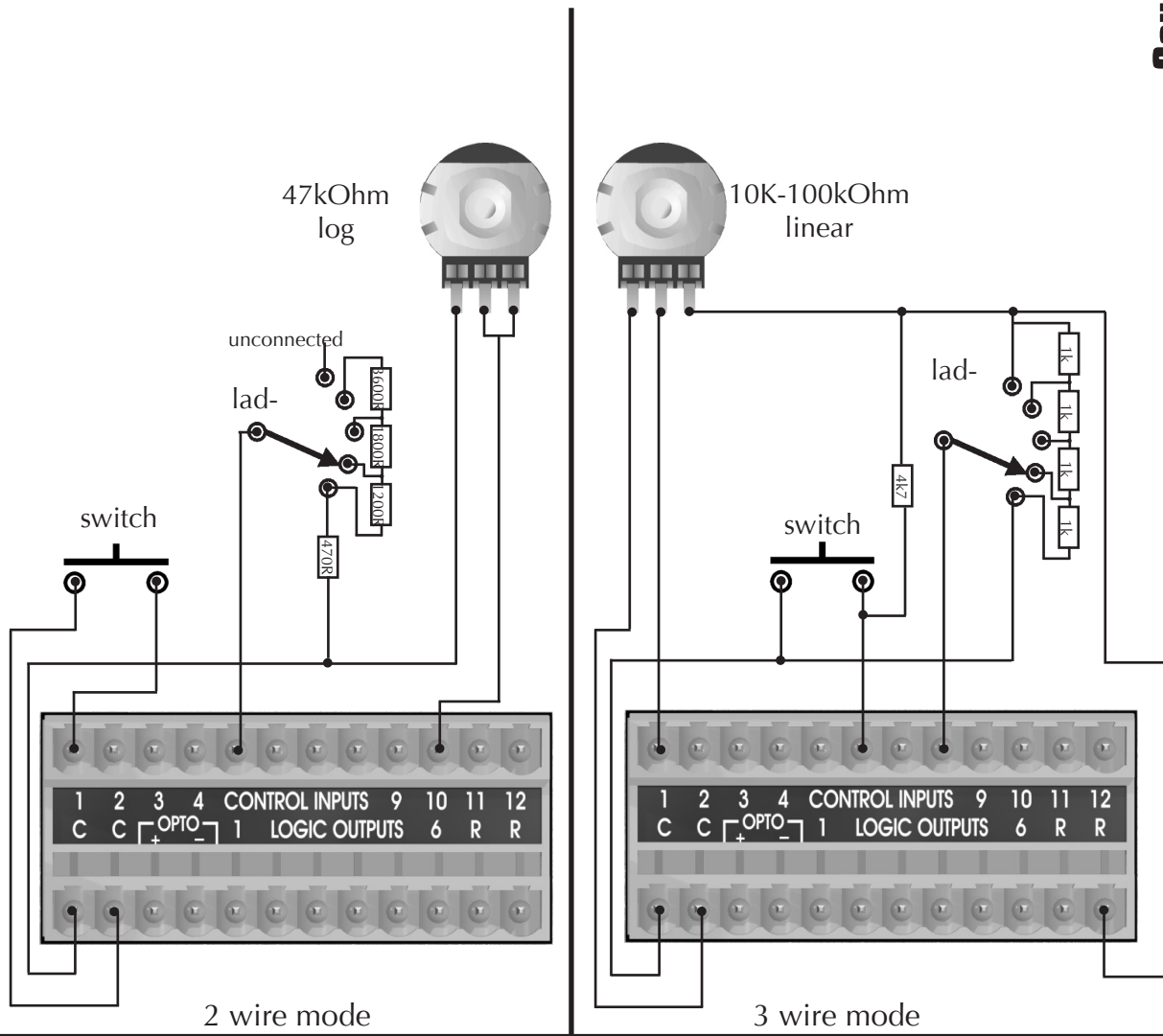

Technical specifications

FRONT PANEL LED INDICATORS

Per Input: Signal Present, CLIP, SYNC/48V, I/O card type (IN, OUT, DIG, AEC(BLU-800, 320, 160, 120))

Other: LCD Display, Conductor active, Net Link active, Data Activity

ANALOGUE INPUTS:

Up to 16 electronically balanced on Phoenix/Combicon removable screw connectors

Mic/Line Inputs:

Nominal gain 0dB, electronically switchable up to +48dB, in +6dB steps

Input impedance:

3.5kOhm

Maximum input level:

+20dBu with 0dB input gain, (+8dBu with 12dB gain)

CMRR: >75dB at 1kHz

Equiv. Input Noise (EIN):

<-128dBu typ. with 150 Ohms source

Phantom power:

48V nominal, selectable per input

A/D Latency: 38.7/Fs

DIGITAL INPUTS:

Up to 16 AES/EBU or S/PDIF on Phoenix/Combicon removable screw connectors

Input impedance:

110 ohm (AES/EBU), 75 ohm (S/PDIF)

Sample Rate:

48kHz or 96kHz

Sample Rate conversion:

8kHz-96kHz

THD + N:

<-140dB

Latency:

3/Fso + (56.581/Fsi) + (55.658/Fso)

ANALOGUE OUTPUTS:

Up to 16 electronically balanced on Phoenix/Combicon removable screw connectors

Maximum Output Level:

+19dBu

Frequency Response:

20Hz to 20kHz (+0.5/-1dB)

THD:

<0.01% (20Hz to 20kHz, +10dBu output)

Dynamic Range:

108dB typ. (22Hz to 22kHz unweighted)

Crosstalk:

<-75dB

D/A Latency:

28/Fs

DIGITAL OUTPUTS:

Up to 16 AES/EBU or S/PDIF on Phoenix/Combicon removable screw connectors

Input impedance:

110 ohm (AES/EBU), 75 ohm (S/PDIF)

Sample Rate:

48kHz or 96kHz

Sample Rate conversion:

8kHz-96kHz

THD + N:

<-140dB

Latency:

3/Fso + (56.581/Fsi) + (55.658/Fso)

CONTROL PORTS:

12 inputs and 6 outputs

Control Input Voltage:

0 to 4.5v

Control Input Impedance:

4.7kOhms to +5V (2-wire mode) >1MOhm (3-wire mode)

Logic Output Voltage:

0 or +5V unloaded

Logic Output Impedance:

440 Ohm

Logic Output Current:

10mA source, 60mA sink

WATCHDOG OUTPUT:

Phoenix/Combicon connector for failsafe control

Opto Output current:

14mA maximum

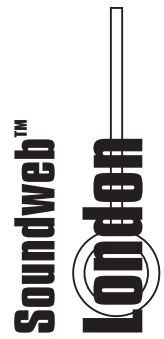

Withstanding voltage: 80V maximum (Off)
Series Impedance: 220 Ohms (isolated)

CONTROL NETWORK (All Models)

Connectors: RJ45 Ethernet connector
Maximum cable length: 100m/300ft on Category 5 cable between device and Ethernet switch

BLU-Link™ AUDIO NETWORK (BLU-800, 320, 160, 120)

Connectors: 2 x RJ45 Ethernet connectors
Maximum cable length: 100m/300ft on Category 6 cable between devices

CobraNet™ AUDIO NETWORK (BLU-80, 32, 800, 320)

Connectors: 2 x RJ45 connectors
Maximum cable length: 100m/300ft on Category 5 cable between device and Ethernet switch

Mains Voltage: 100-240V AC, 50/60Hz
Power Consumption: <35VA (BLU-80, 32, 16); <55VA (BLU-800, 320, 160, 120)
BTU Rating: <120 BTU/hr (BLU-80, 32, 16); <188 BTU/hr (BLU-800, 320, 160, 120)
Operating Temperature Range: 5(41) to 35(95) degrees C(degrees F)

BSS Audio incorporates high quality mechanical fans in some products. All mechanical fans have a limited life expectancy. We recommend annual inspection of fans for dust occlusion and excessive noise. Fan assemblies should be replaced after six to ten years of use. Environmental factors such as elevated temperature, dust, and smoke can adversely affect fan life. Systems exposed to these conditions should be inspected more frequently. Fan replacement can be performed either at the factory or by an experienced technician in the field. Please contact BSS Technical Support for more information on purchasing replacement parts or product service.

BSS Audio has a policy of continued product improvement and accordingly reserves the right to change features and specifications without prior notice.





BSS Audio
8760 South Sandy Parkway
Sandy, Utah 84070
801-566-8800
www.bssaudio.com

